

Bread slicers for professionals

Integra^{pro}

- ✓ Design: perfect integration into the counter
- ✓ Versatile
- ✓ Fast: Adjustable speed from up to 240 slices / min
- ✓ Easy: Intuitive touch interface
- ✓ Maximum safety
- ✓ Exemplary hygiene

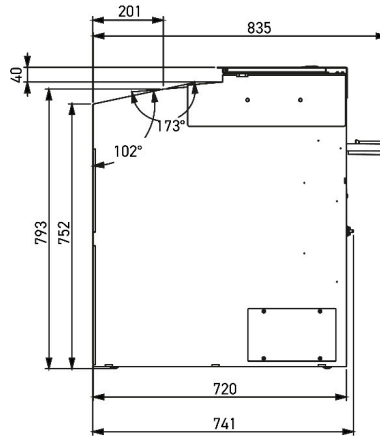

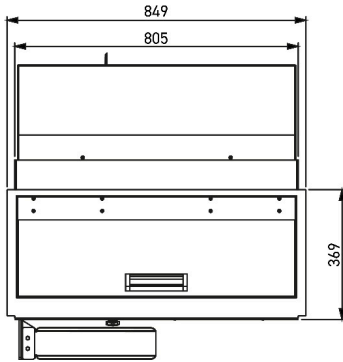
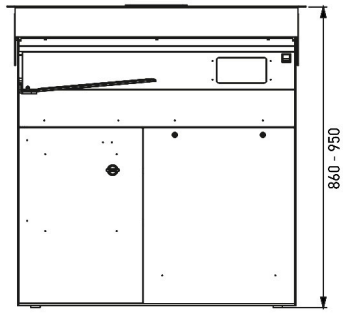

SPECIFICATIONS

Size of entry channel (L x W x H) in cm	38 x 34 x 16
Slice thickness in mm	Can be set from 5 to 25mm
Power supply	220V single-phase
Motor power in kW	0.75
Net weight (in kg)	230
Manual claw	•
Blade type and dimensions in mm	420 mm diameter, Teflon-coated
Options (Additional cost)	Automatic claw, Bag holder, Rustic bread holder

MAIN STRENGTHS

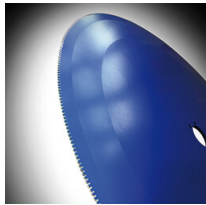

Smooth and quiet for all breads

New engine generation designed for maximum precision on a wide range of breads, without lubrication. Soft start and stop function.



Teflon coated circular blade

Developed to cut through a large variety of breads; from soft to dense, with a hard crust, and even sticky breads.

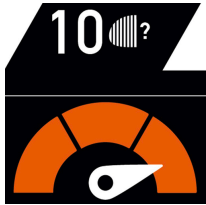

Adjustable speed up to 240 slices/ minute

In order to reach the fastest possible speed for each bread type.

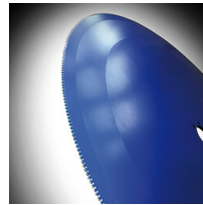

Planetary blade drive

Fluid blade movement, avoids back-and-forth shakes. Robust solution for long-term mechanical reliability.



Automatic grip (option)

Just place the bread and the machine does the rest while you continue to serve your customers.



Manual grip

For all kinds of breads, including sharp ends. Allows to minimize last slice width.



Easy to access power switch

Accessible from the front of the machine, but not visible; avoids operations by a non-authorized person.



Maximum safety

Highest safety standards, for machine use by consumers and staff. The blade cannot run when the machine is not 100% locked.

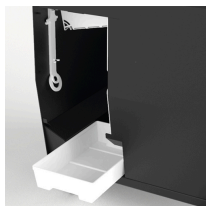

Easy & fast cleaning

Internal architecture designed to channel bread crumbs to an easily accessible crumb tray. Flat surfaces (without recess around).



Intuitive touch interface

Clear and simple interface, for an immediate and intuitive use



BPA-free paint

100% BPA-free satin paint (Bisphenol A): safer for you, gentler on the planet. Its low-temperature curing process significantly reduces energy consumption. Available in three solid colours: white, black or grey.