

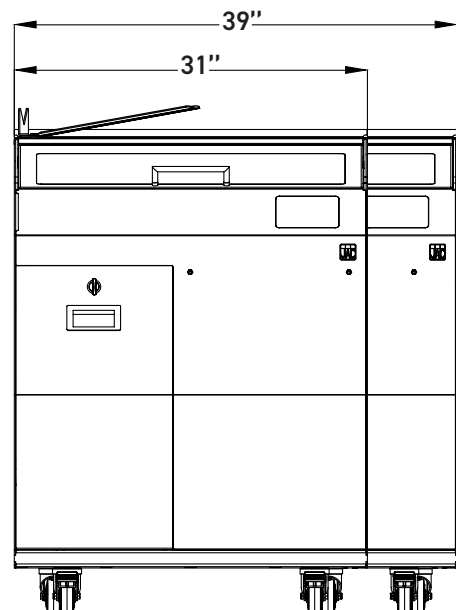

- **Versatile**
- **Fast**
Varia pro: Adjustable speed from 120 to 240 slices / min
Varia self: 180 slices / min
- **Easy:** Intuitive touch screen
- **Maximum safety**
- **Exemplary hygiene**

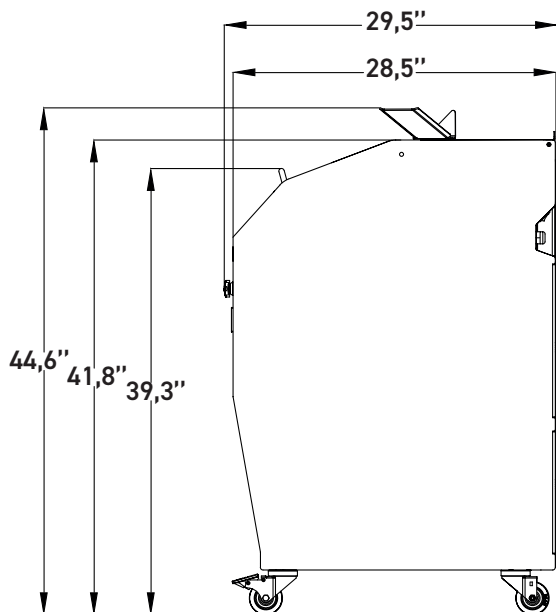

Best-in-class slicing performances for a wide range of bread



Smooth and quiet for all breads

- New engine generation designed for maximum precision on a wide range of breads, without lubrication
- Soft start and stop function

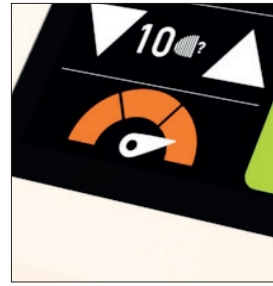

VARIA PRO

Adjustable speed up to 240 slices/minute

- In order to reach the fastest possible speed for each bread type

VARIA SELF

Adjustable (to be performed by technician) speed up to 180 slices / minute

- In order to use a speed that allows users to cut the entire product line without any worry.



Teflon coated circular blade

- Developed to cut through a large variety of breads; from soft to dense, with a hard crust, and even sticky breads

Planetary blade drive

- Fluid blade movement, avoids back-and-forth shakes
- Robust solution for long-term mechanical reliability

State-of-the-art ergonomics



Dual PRO & Self touch screen controls

PRO

- Clear and simple interface, for an immediate and intuitive use



SELF

Touch screen interface and consumers instructions

- Step by step instructional graphics

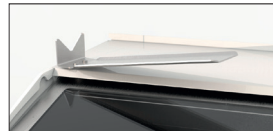

Multi-positions adjustable bagging spade

- Rotating spade, above cutting chamber, to optimize ergonomics and hygiene
- Two standard (left and right) bagging spade positions
- Or non-rotating front position (option)



Automatic claw

- Just place the bread and the machine does the rest while you continue to serve your customers



Upper cover

- Prevents objects placed on the machine (e.g. bags) to be pushed inadvertently behind the machine when opening the front cover
- Rotates for easy cleaning

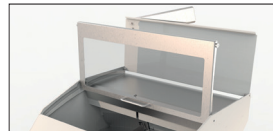

Manual claw (option)

- For all kinds of breads, including sharp ends
- Allows to minimize last slice width

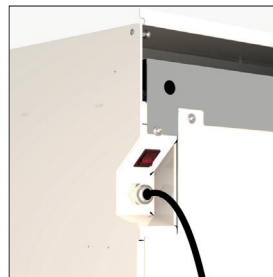

Easy to access power switch

- Accessible from the front of the machine, but not visible; avoids operations by a non-authorized person



Lighting guidance and ambiance

- Lights insertion zone then exit zone





Maximum safety

- Highest safety standards, for machine use by consumers and staff
- The blade cannot run when the machine is not 100% locked

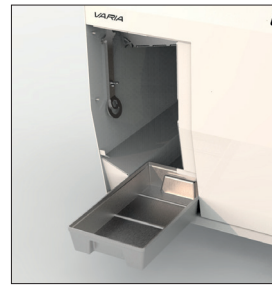

Smooth and cleanable surfaces

- Internal architecture designed to channel bread crumbs to an easily accessible crumb tray
- Flat surfaces (without recess around)

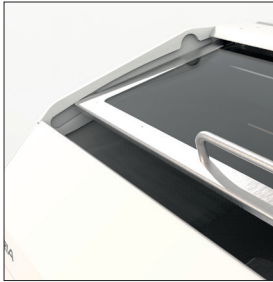

Anti-pinch design

- Users cannot inadvertently pinch their fingers in the front cover sliders

Accessories to enhance staff and consumer experience

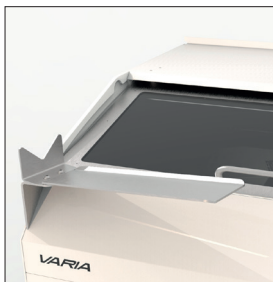

- 10 cm Front bagging stand



- Bag holder

Features

FEATURES

	VARIA 800	VARIA 1000
Maximum loaf dimensions (L x W x H) in inches	14,9" x 13,4" x 6,3"	19,3" x 13,4" x 6,3"
Slice thickness in mm	Can be set from 4 to 30mm	Can be set from 4 to 30mm
Power supply	208-230v/1p	208-230v/1p
Plug Configuration	NEMA L6-20P*	NEMA L6-20P*
Motor power in kW	0.75	0.75
Net weight in lbs	507	507
Blade type and dimensions in inches	16,5" diameter, Teflon-coated	16,5" diameter, Teflon-coated
Automatic claw	•	•
10 cm Front bagging stand	•	•
Bag holder	•	•
Led lights	•	•
Dual Pro & Self touch screen controls	•	•
Upper cover	•	•
Cleaning position	•	•

OPTION

Manual claw	•	•
-------------	---	---

*

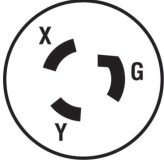

L6-20P

Plug Configuration
• NEMA L6-20P



Warranty valid for all parts on your machine, including electronic components but excluding consumables.

Please do not hesitate to contact your approved dealer for further information.

